

cod.893M0317

ARPA 18_2

IRP00116_2

Istruzioni di montaggio ed uso
Operation instructions
Instructions de montage et usage
Montage-und Bedienungsanleitung
Instrucciones de montaje y uso
Instrucțiuni pentru montare și utilizare

IRSAP

creating your comfort

IRSAP SPA

45031 Arquà Polesine (RO) Italy
Tel. +39 0425 466611 - Fax +39 0425 466662
Website: <http://www.irsap.com>
E-mail: info@irsap.it

IR GROUP SARL

19, Chemin de la Plaine 69390 Vourles (France)
Tel. +33 04 28 00 01 67 - Fax +33 04 72 31 86 40
Web: <http://www.irsap.com>
E-mail: irsaphoss@irgroup.fr

IRSAP-RHOSS Clima Integral, S.L.

Oficina y Almacén: P.I.CAMI RAL
Leonardo da Vinci, 4 08850 Gavà (Barcelona)
Tel. 93 633 47 00 - Fax 93 633 47 04
E-mail: www.informacion@irsap.com
www.irsap.com

IRROM Industrie S.R.L.

Str. Pricipală 1/A, Sat Fundătara, Iclod 407336,
jud. Cluj, România
Tel: +40 (0)264 263400 - Fax: +40 (0)264 263404
Web: www.irsap.ro

Accessori non inclusi-Accessoires non
compris-Accessories not included-Zubehör nicht
inklusive-Accessorios no incluidos-Accessorii neincluse

Cmax = Coppia massima di serraggio Cmin = Coppia minima di serraggio
Cmax = Maximum torque Cmin = Minimum tightening torque
Cmax = Couple de serrage Cmin = Couple minimum de serrage
Cmax = Max anzugsmoment Cmin = Mindest-Anziehmoment
Cmax = Esfuerzo máximo de cierre Cmin = Par de torsión mínimo
Cmax = Cuplu de strângere maxim Cmin = Cuplu de strângere minim

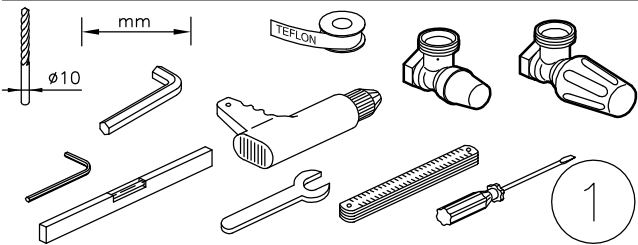

Accessori inclusi-Accessoires compris-Accessories
included-Zubehör inklusive-Accessorios incluidos-Accessorii incluse

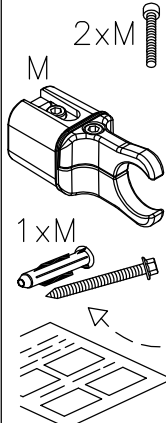

Fissaggi da utilizzare solo su
pareti in muratura piena/forata.
Brackets to be used only on
walls made of solid
bricks/perforated bricks.
Fixations à utiliser uniquement
sur les murs en maçonnerie
pleine/perforée.
Befestigungen zur Verwendung
auf Vollziegel/Hochlochziegel.
Fijaciones a utilizar únicamente
en paredes de Ladrillo
macizo/perforado.
Fixare pentru utilizare doar pe
pereți în zidărie plină/perforată.

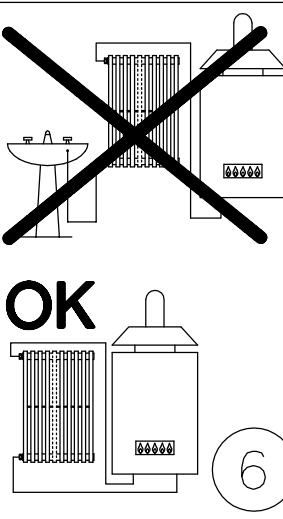
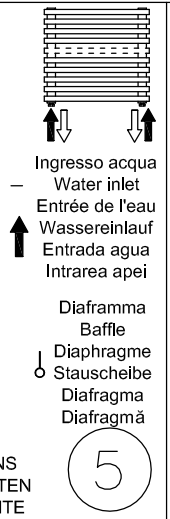
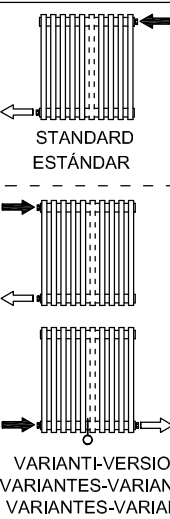
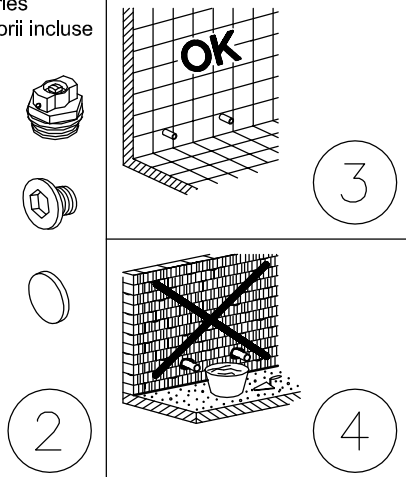

Modello-Model Modèle-Bautyp Modelo-Modelul	n°				
	2÷35	36÷39	40÷43	44÷48	49÷50
H	M				
420	4	4	4	4	4
520	4	4	4	4	4
550	4	4	4	4	4
650	4	4	4	4	4
670	4	4	4	4	4
700	4	4	4	4	4
750	4	4	4	4	4
850	4	4	4	4	4
870	4	4	4	4	4
920	4	4	4	4	4
1220	4	4	4	4	4
1520	4	4	4	4	4
1820	4	4	4	4	6
2020	4	4	4	4	6
2220	4	4	6	6	6
2520	4	6	6	6	6

M=Numero di mensole parete consigliate
M=Number of recommended wall brackets
M=Nombre de consoles conseillées
M=Empfohlene Anzahl an Wandkonsolen
M=Número de soportes aconsejados
M=Numărul de cârlige pentru perete recomandat

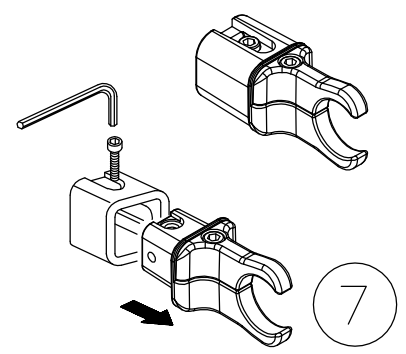

Con anello di battuta
With beat ring
Avec bague de butée
Mit Anschlagring
Con anillo de tope
Cu inel de oprire

Senza anello di battuta
Without beat ring
Sans bague de butée
Ohne Anschlagring
Sin anillo de tope
Fără inel de oprire

